

# BODY SHOP STRUCTURAL INSERTS SAFER RIDES; ADDED STRENGTH START WITH SIKA

LIGHTER | STRONGER | SAFER | QUIETER | GREENER

BUILDING TRUST



# YOU NEED TO FIND WAYS TO MAKE YOUR NEXT VEHICLE LIGHTER, STRONGER, SAFER, QUIETER OR GREENER.

## **SO WHERE DO YOU START?**

Start with a trusted partner that can deliver global innovation on a localized scale, wherever and whenever it's needed. Start with a commitment to continuous improvement, and the knowledge that it takes years to become an overnight success. Start with a collaborative approach that can bring together great minds without knocking heads. Start with pioneering innovation that clears a path for the vehicles of the future, no matter what form they take.

## **START WITH SIKA**

With a full suite of bonding, damping, sealing and reinforcing solutions, Sika is a key strategic partner for both OEMs and component suppliers. By collaborating on advanced body shop assembly development projects and engaging early in program development, we help customers optimize designs, identify cost savings and reduce complexity.

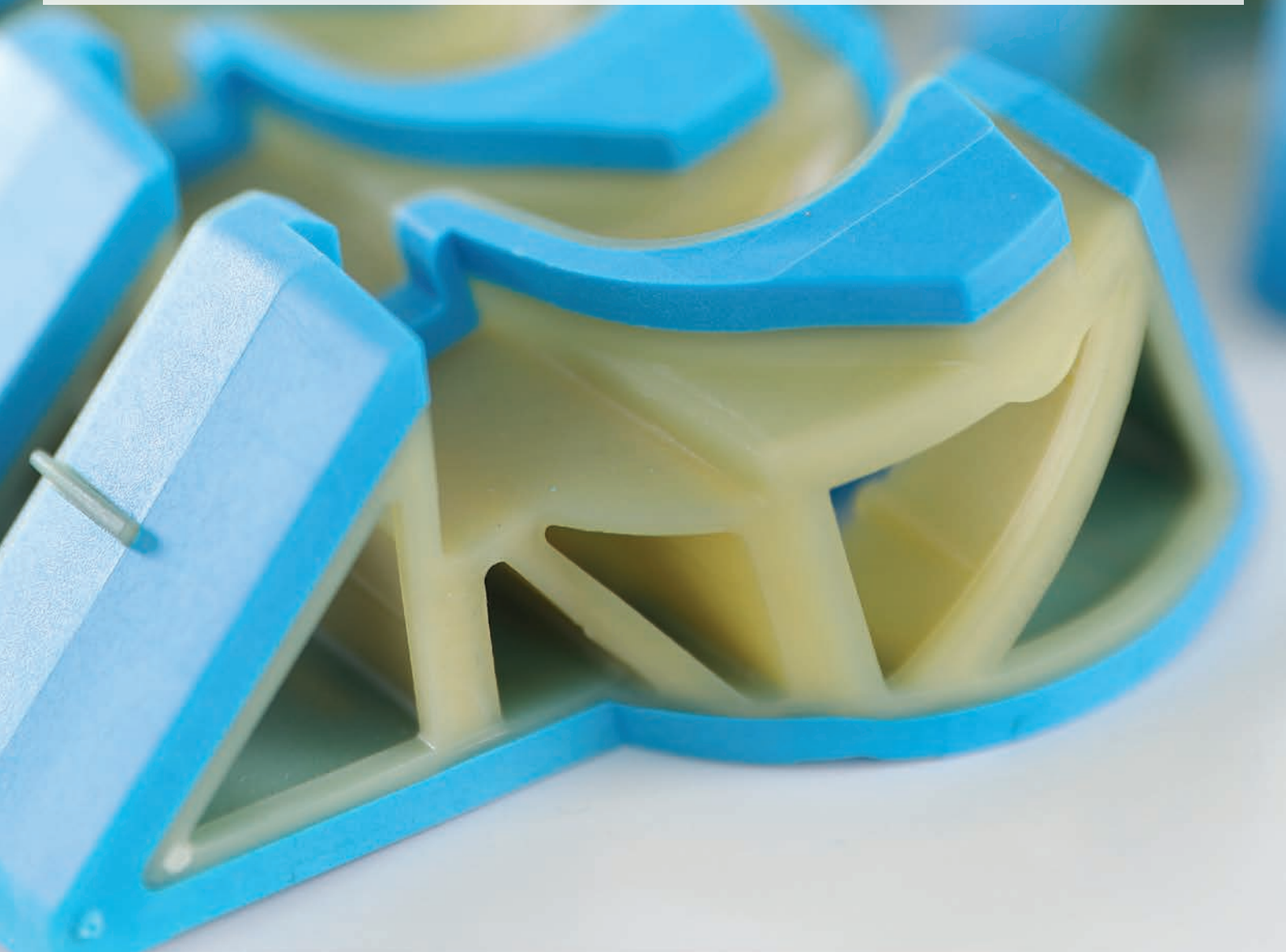

# CONTENT

**05** Design Safer and more Comfortable Vehicles

---

**06** Achieve Safety Performance

---

**07** SikaReinforcer® - Product Range

---

**08** Improved Safety with High Strength Bonding and SmartFlow HSB

---

**10** Product Overview

---

**13** Improved Driving Comfort

---

**14** Lightweight Solutions

---

**15** Improve Panel Stiffness

---

**16** Structural Tapes

---

**18** Innovation: It Starts with Passion

---

**19** Start with Sika

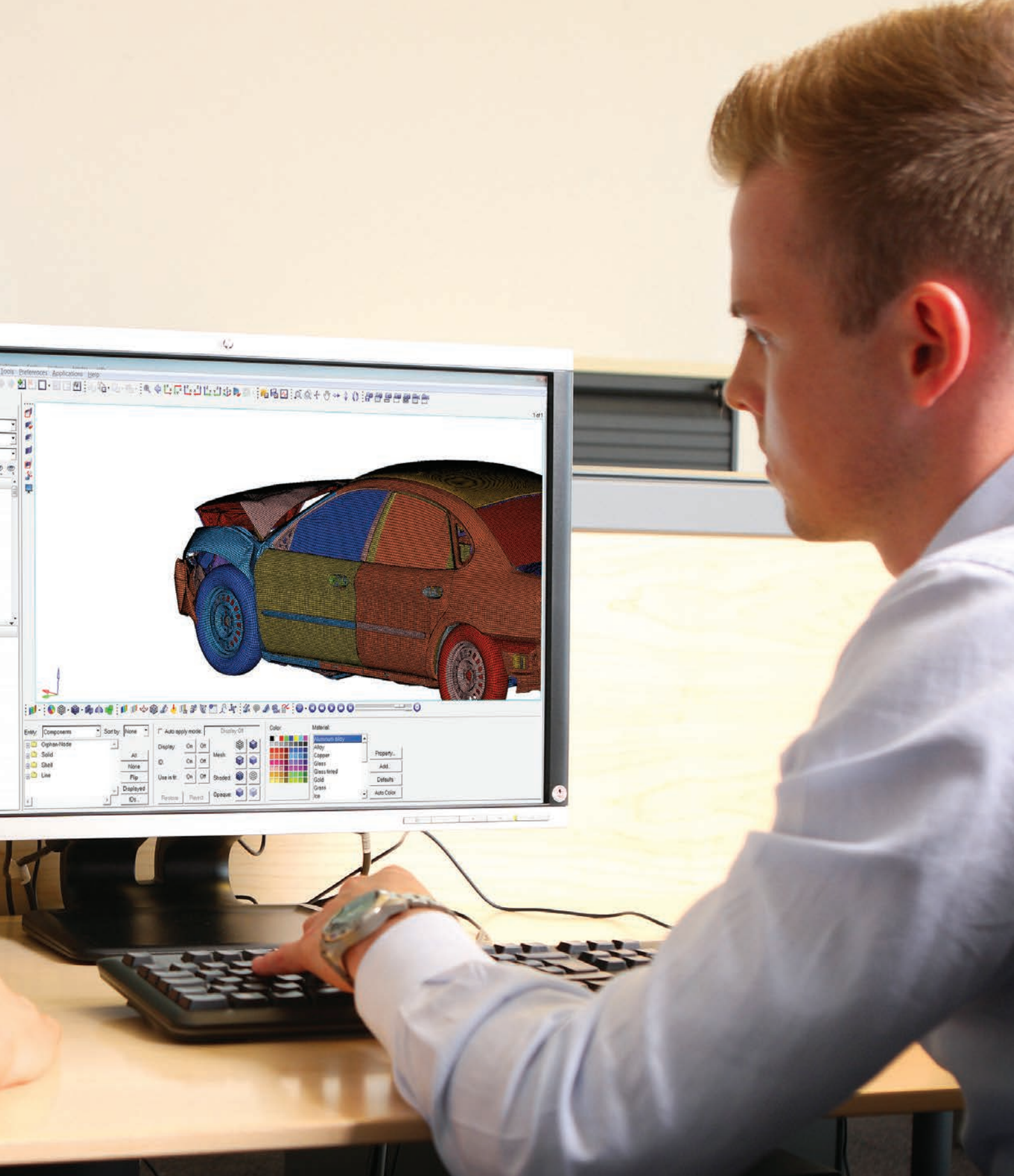

## 50,000 TONS OF STEEL SAVED ANNUALLY WORLDWIDE

Vehicle weight reduction targets are achievable when using SikaReinforcer® or high strength bonding systems in conjunction with mass reduction design; all the while maintaining or enhancing crash safety, durability and vehicle dynamics.

# DESIGN SAFER AND MORE COMFORTABLE VEHICLES

Reinforcing Solutions with SikaReinforcer® and SikaPower®

**OUR VERSATILE STRUCTURAL INSERT** technologies reinforce car body structures while delivering a variety of process and performance benefits; the ability to reduce mass AND improve crash performance. Three dimensional parts, CAD designed and CAE optimized, are engineered for the specific vehicle geometries. The final component consists of a SikaStructure® carrier, molded from proprietary Sikamid® and then secured in the vehicle using either a thermal epoxy foam (SikaReinforcer®, two shot molded) or a high-strength structural adhesive (SikaPower®). Together, or separately, these technologies help create lighter weight, performance proven structures, and enable the creation of a new generation of car body concepts; Lighter, Stronger and Safer designs through selective and highly targeted reinforcements.

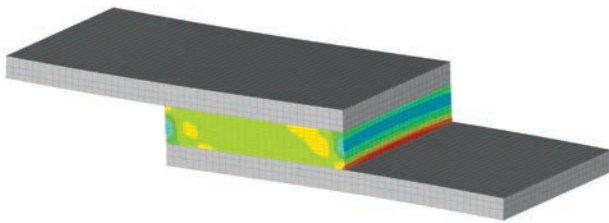

## START YOUR DEVELOPMENT WITH SIKA

Sika's extensive engineering capabilities include CAE simulation, product development and validation. The vast global network of technology centers and manufacturing footprint provide support to the broad portfolio of proven products. The combination ensures Sika will deliver the right solutions for our customers worldwide.

For each steel design, a SikaReinforcer® solution is an alternative for a stronger, safer, greener solution.

By starting early in the design process, designs can be further optimized for greater cost savings and significant weight reduction over traditional methods.

## BENEFITS

- Design flexibility even in complex design environments
- Implementable without significant modification of the engineering design
- Easy assembly process in car body
- Shorter design and development timeline than steel solutions
- Can be added at any point during the body development process

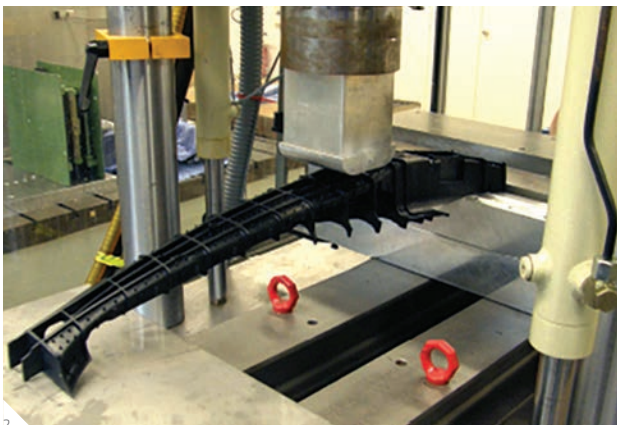

1 CAE simulation lap shear specimen  
2 B-pillar mechanical bending test

# ACHIEVE SAFETY PERFORMANCE

Reduce Deformations with SikaReinforcer®

**SAFER RIDES: MEET EVER INCREASING SAFETY REQUIREMENTS WITH SikaReinforcer® AND HIGH STRENGTH BONDING (HSB)** Conventional solutions to reduce collapse and deformation of sections in car body structures utilize metal reinforcements, which can increase material thickness, weight and processing complexities. Alternatively high-strength metal can be used, but it adds cost. Sika's solutions provide methods to mitigate these challenges.

## IT IS NOT SAFETY FIRST, IT IS SAFETY ALWAYS: MEETING ALL OF YOUR REQUIREMENTS

A wide range of highly engineered structural solutions including SikaReinforcer® foam and SikaReinforcer® High Strength Bonding (HSB) can be integrated during the design phase of your project for maximum benefit in vehicle assembly and performance.

SikaReinforcer® structural inserts help efficiently distribute the load of crash stresses over a larger geometry of substrates and ensure high levels of crash performance without adding excessive weight, cost or complexity. This allows designers and engineers to imagine new design and assembly possibilities and push the limitations of conventional vehicle designs by utilizing ever-thinner sheet metal or reducing car body structure sections without compromising crash performance.

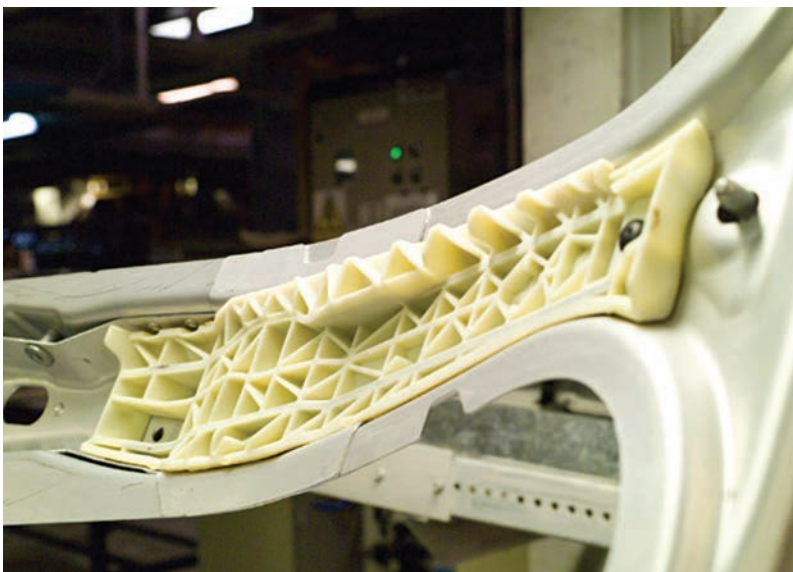

1 B-pillar

## APPLICATION

- A-, B-, C- and D-pillars (upper and lower at nodes positions)
- Roof frames
- Rocker, sill

## BENEFITS

- Limits collapse of body sections
- Reduces intrusion in passenger compartment
- Lightweight solution versus heavier metal solution

# SIKA REINFORCER SAFETY PRODUCT RANGE

## SIKA OFFERS TAILOR MADE SOLUTIONS TO MULTIPLE BODY SHOP ASSEMBLY CHALLENGES

For each type of requirement in crash, local stiffness, NVH and fatigue, Sika's broad reinforcer product range allows for the best design and technical solution; always adapted to the car body design, the planned assembly process and the development timeline. Our engineers propose the most optimized solution for the best results.

### KEY PERFORMANCE DATA - NVH

In pursuit of lightweighting goals, automakers increasingly turn to thin UHSS (ultra high strength steel). However, this results in increased noise, vibration and harshness in the vehicle that need to be compensated with reinforcements

- Foamed reinforcers placed at structural nodes can increase torsional and bending frequency by 3Hz
- Increase torsional stiffness by up to 10%
- Torsion stiffness can be increased by +2000 Nm/°
- Factor 2-3 higher efficiency for each mass added compared to stiffness

### KEY CRASH PERFORMANCE DATA - DROP TOWER TESTING

SikaReinforcer® technology contributes to:

- Suppression of buckling
- Direct load transfer inside section of car body
- Reinforcement of geometrically weak and vulnerable areas

### DEFORMATION PERFORMANCE IN DROP TOWER TESTING

Comparative crash behavior of 3 reinforcement solutions in drop tower test on a hat profile:

- HSB can withstand the highest load and reduce deformation in car body section

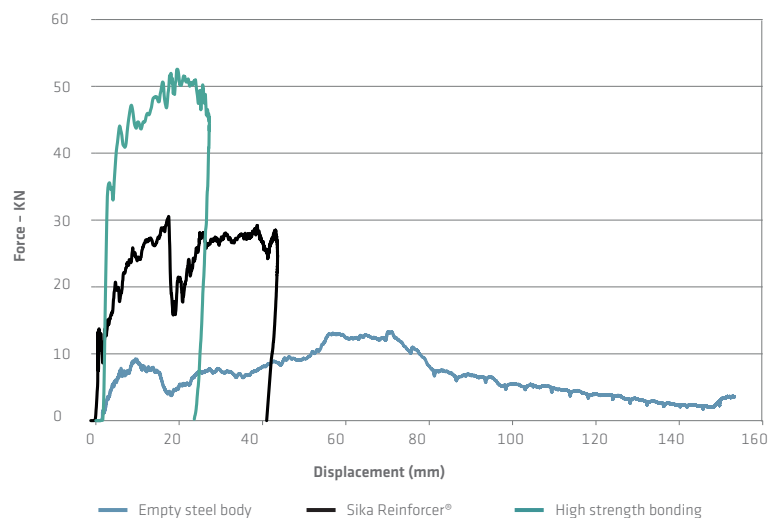
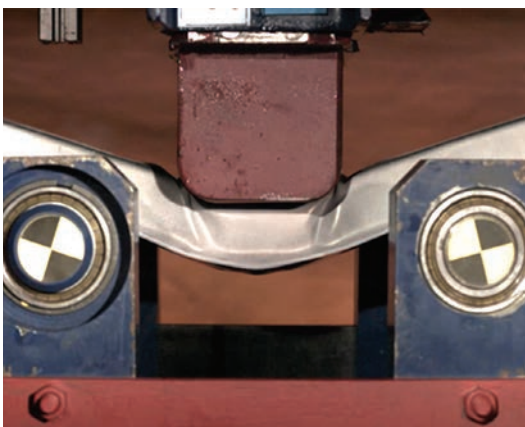

# HIGH STRENGTH BONDING

Improve Safety Performance with High Strength Bonding (HSB)

**NEW TECHNOLOGY: HIGH STRENGTH BONDING** SikaReinforcer® HSB is an exciting new technology which combines the energy absorption of a complex highly engineered injection molded SikaStructure®, with the strength of structural adhesives, SikaPower®. It is designed for combined assembly into the vehicle body structure and therefore creates the highest crash performance at the lowest weight possible.

## APPLICATION OVERVIEW

With documented performance in crash load tests, SikaReinforcer® HSB technology offers exceptional possibilities to reinforce sections of car bodies, even in space constrained design architectures. The reliable adhesion and high strength crash performance of SikaPower® adhesives results in a graduated distribution of the kinetic forces throughout the specific area of impact and surrounding bonded material. The reinforced section limits intrusion into the occupant safety cell of the vehicle and limits local deformations such as buckling or tension that exceed the elastic limits of the surrounding metal.

SikaReinforcer® HSB is characterized by its exceptional robustness in a crash event leading to plastic deformation in terms of performance and the technology exhibits excellent aging stability over the service life of the vehicle. This technology has been developed and tested to fulfill the most exigent crash requirements, offering designers a high potential of advanced lightweight design possibilities while maintaining or enhancing crash performance.

## ASSEMBLY PROCESS FOR HSB APPLICATION

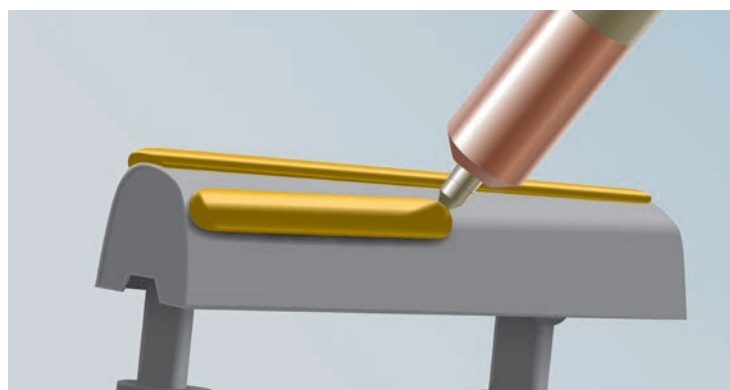
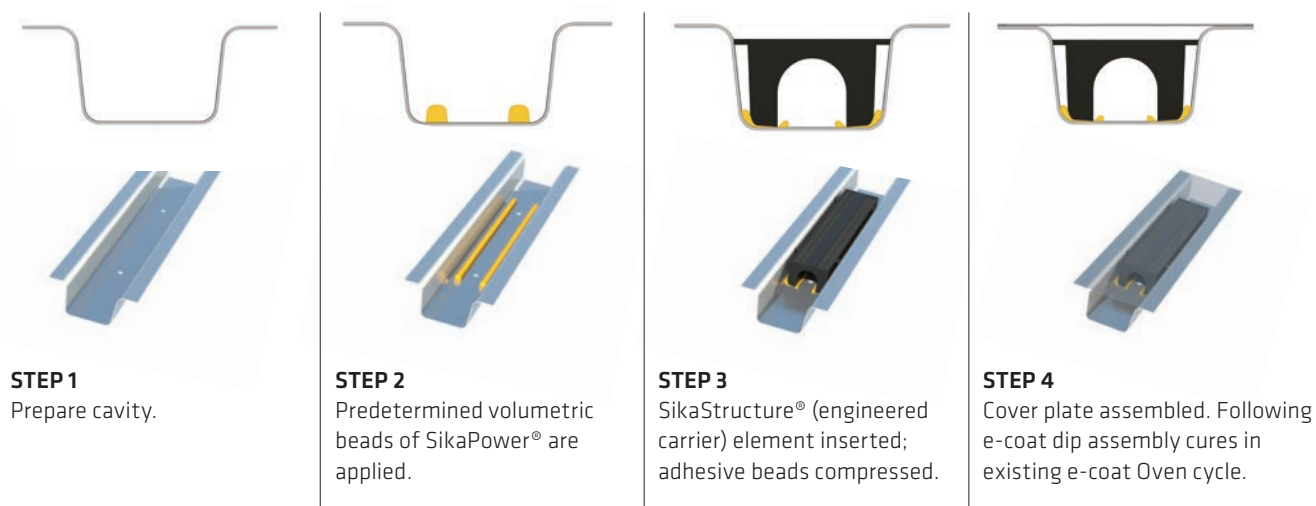

## BENEFITS

- Highest performance at lowest weight
- Weight reduction from 20% to 40% when compared to equivalent performing metal solution
- Flexible design possibilities – can be adapted to any complex metal sheet design (even in space constrained cavities)
- Easy implementation for derivative models, such as hybrid or electric versions



# NEXT GENERATION

Sika HSB SmartFlow

**NEW DEVELOPMENTS** continue to push performance to higher levels. As a leader in reinforcement applications and technologies we continue to be an innovation leader in future assembly techniques AND boundaries of crash performance. Sika SmartFlow technology allows for automated injection of measured amounts of adhesive; exactly where it is needed for maximum performance.

## APPLICATION OVERVIEW OF SMARTFLOW HSB

Instead of applying the structural adhesive on the plastic reinforcement front, as in HSB concept, engineered cavities receive the reinforcer part. The section is then closed and the structural adhesive is injected through a portal after assembly. The injection canals are not necessarily sealed (gap up to approx. 1mm).

Ideal applications include reinforcement of locally extruded aluminum profiles, or steel rolled sections where the HSB process would be impossible to use.

## ASSEMBLY PROCESS FOR SMARTFLOW HSB APPLICATION

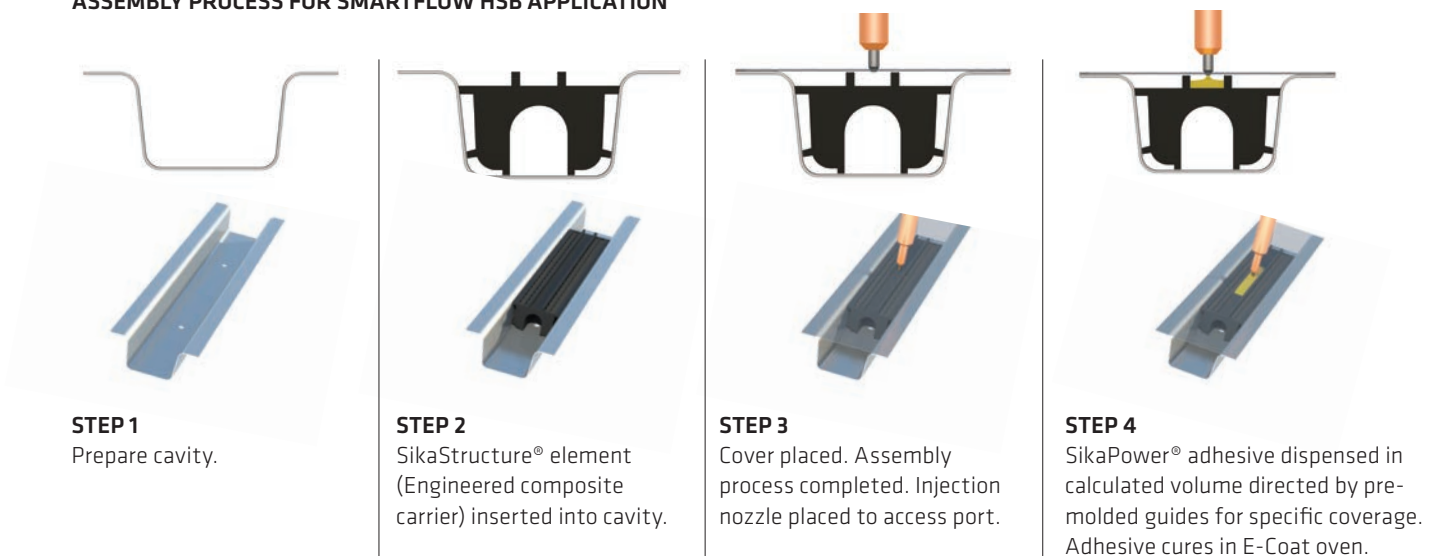

# PRODUCT OVERVIEW

Crash Safety, NVH and Local Stiffness Solutions

## **SikaReinforcer® HSB (CRASH): HIGH STRENGTH BONDING**

In highly loaded crash applications, HSB technology is a method of choice, and particularly suited to the reinforcement of long, tight geometry sections of the car body. After crash, deformation of the specific section exhibits smooth, linear dispersion of energies; without rupture of, or buckling of the surrounding sheet metal. e.g. applications in the roof frame, A-B-C D-pillars for side crash protection, small overlap, or roof crash.

## **SIKA SMARTFLOW HSB**

In case of application in closed sections (e.g. extruded aluminum profiles, cold rolled steel) our newly developed Smartflow solutions allows placement of a highly engineered carrier in the closed section and the SikaPower® material is injected through a portal after assembly.

## **SikaReinforcer® (CRASH):**

SikaReinforcer® applications are ideally suited for side, front or rear crash and well adapted for crash applications where the dominant energy load is compression. Typical application is the bridging of a gap between two metal sheets, and in filling small cavities loaded for compression. e.g. Reinforcer in A, B, C, D-pillars

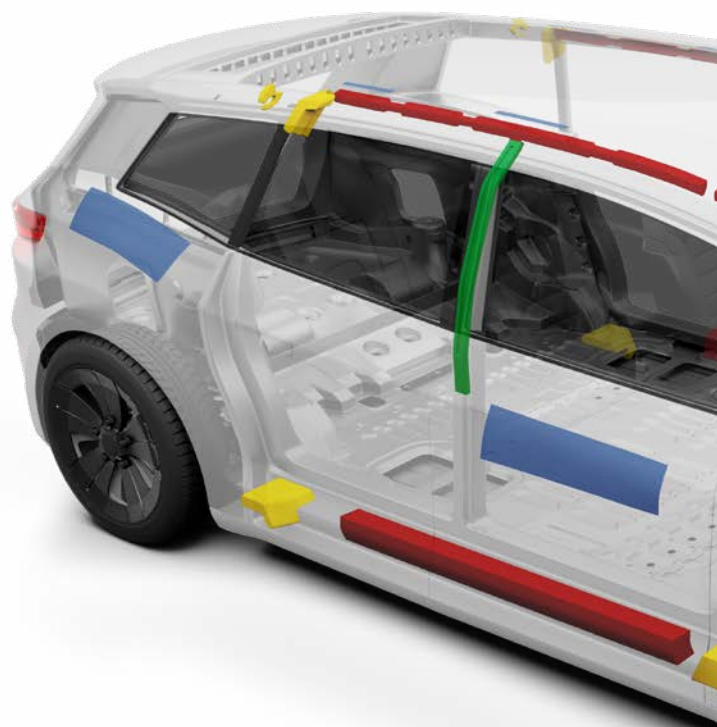

## **SikaReinforcer® (REPAIR):**

Our OEM solutions follow vehicles to the field for use in repair. Packaged for aftermarket use, two-component structural adhesive SikaReinforcer®-900 cartridge can be used in combination with SikaStructure® inserts, as an ideal solution for repair in car body sections.



**SikaReinforcer® (NVH enhancement):**

Dynamic bending or torsional stiffness can be improved on either a local or global level with the insertion of structural inserts in strategic nodes. e.g. A, B, C-pillar lower, A-pillar to roof frame, C-pillar

**SikaReinforcer® (Local stiffness improvement):**

Local static stiffness can be improved by stiffening the sections of the car body with structural inserts. The technology provides simple alternatives to complex steel solutions (stamping, welding, bonding). SikaReinforcer® parts are more simple to integrate in the assembly process and weigh less than steel solutions. e.g. roof frame, windshield's carrier, sill

**SikaReinforcer® (Panel stiffening)**

Weight saving efforts in design often involve reduced panel thicknesses. These actions can lead to localized external panel weaknesses that can be compensated easily through the addition of stiffener products. SikaReinforcer tapes and pads, or bulk applied reinforcer technologies are ideally suited for remediation of these challenges.

**PRODUCT KEY**

- SikaReinforcer® HSB (High Strength Bonding) for high loaded crash
- SikaReinforcer® for crash
- SikaReinforcer® pads for local stiffness
- SikaReinforcer® for NVH enhancement



## **SAVE MASS, SIMPLIFY BODY DESIGN, MAINTAIN OR IMPROVE VEHICLE DYNAMICS**

For large cavity openings such as body pillars or rocker areas, reduction of mass is easily achieved with highly engineered, custom molded parts to reinforce the vehicle body structure. As traditional mass comes out, lighter weight solutions go in.

# IMPROVED DRIVING COMFORT

NVH: Quieter Rides With SikaReinforcer®

**COMFORTABLE RIDES: IMPROVING DRIVING COMFORT** NVH (Noise, Vibration & Harshness) and body stiffness complaints continue to top vehicle quality studies, but addressing them by simply adding weight creates new engineering challenges. Vehicle manufacturers need an experienced partner to provide the best possible solution. So where do you start?

**START WITH SIKA** The Same engineering principles applied for Crash Safety lend to our industry leading solutions for NVH Improvements. Our SikaReinforcer® technologies use lightweight, pre-shaped, injection molded parts within the primary body structure sections to effectively control dynamic or static stiffness in torsion or bending of the vehicle body, without adding significant mass.

SikaReinforcer® is an epoxy-based family of products. CAE-designed structural inserts are placed into the cavity of the body structure and cured during the standard E-Coat oven process. The result is a lightweight, durable bridge between the sheet metal cavities that fully stabilizes the structure without adding additional steps to the assembly process. Local structural inserts provide local reinforcement to the structure, allowing engineers to further decrease the thickness of the sheet metal, save mass and simplify body designs.

SikaReinforcer® can be used for manual application in vehicle production as well as for repair and service solutions. For repair, SikaReinforcer® is available as a ready-to-use, two-part foam that cures quickly at ambient temperature.

Sikamid® raw materials are used to create CAE designed, molded carriers for reinforcing applications, and are available with a variety mechanical properties and colors, depending on the technical needs.

## BENEFITS

- Improves full vehicle and local stiffness
- Lightweight solutions versus equivalent steel solution
- Flexible design possibilities
- Simple assembly process - simplified joining method

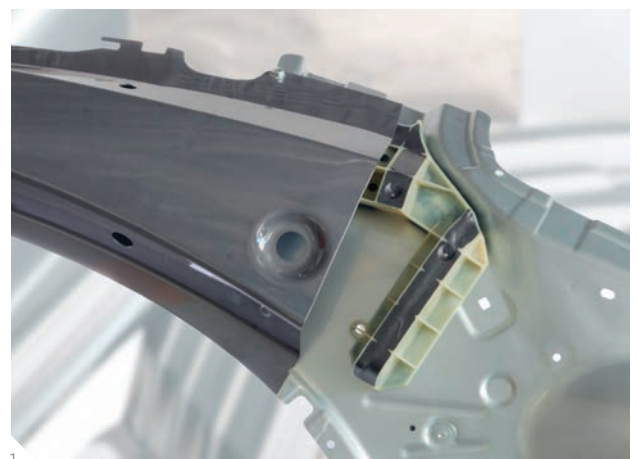

Reinforcer application examples  
1 B-pillar junction with roof frame  
2 C-pillar application

# LIGHTWEIGHTING SOLUTIONS

Reducing Weight with SikaReinforcer® Contributes to Sustainability

## LIGHTER VEHICLES START WITH SIKA

With consumers and government regulators both demanding greater fuel economy, reducing vehicle weight is a key goal in new vehicle development. While there are many options throughout the vehicle to meet new guidelines, lightweight materials offer excellent solutions. SikaReinforcer® solutions offer a potential of 40 kg weight reduction compared to steel equivalent performing solutions.

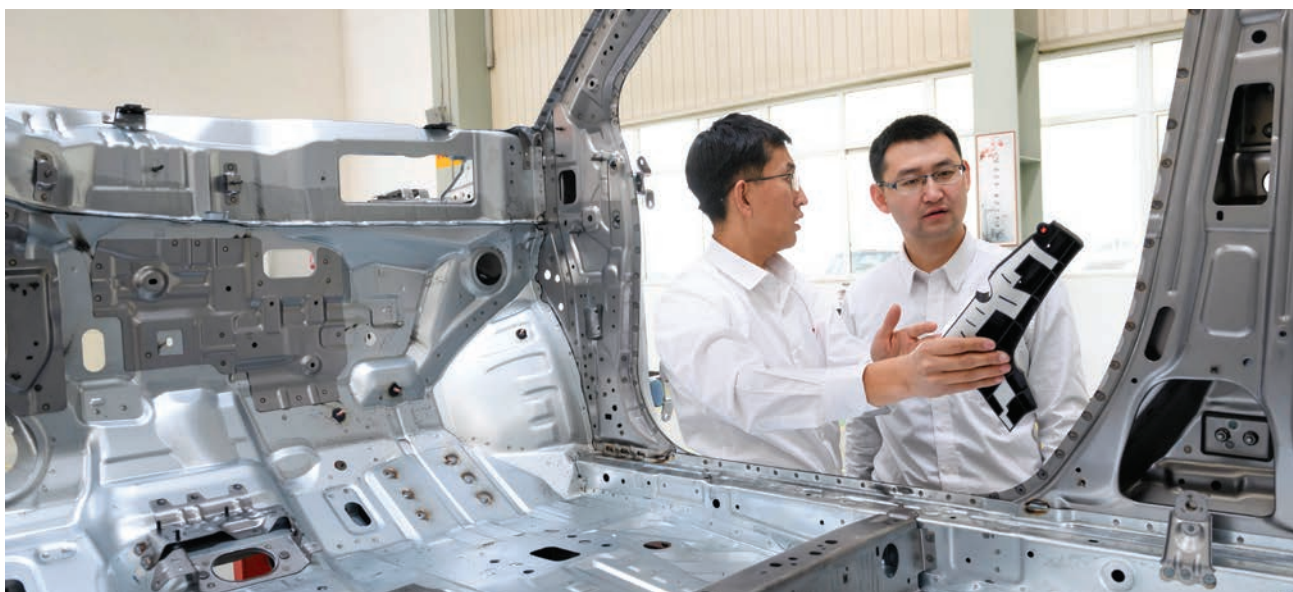

## KEY PERFORMANCE DATA - SikaReinforcer® AND SIKAS HSB TECHNOLOGY

Sika offers multiple reinforcement products in our portfolio, most are adapted to specific customer requirements based on design need and performance requirements.

	SikaReinforcer® -94x family	SikaReinforcer® -95x family	SikaPower®-96x family	SikaReinforcer®-900 R (2C Repair Adhesive)
<b>Curing Window</b>	140 – 200 °C	140 – 200 °C	150-200 °C	20-40 °C (RT)
<b>Expansion</b>	100 – 250 %	150 – 250 %	none	none
<b>Tensile Strength</b>	3 – 17 MPa	8 – 10 MPa	20 – 30 MPa	16 MPa
<b>Young Modulus</b>	380 – 1100 MPa	400 – 600 MPa	1500 – 2000 MPa	2000 MPa

# PANEL STIFFENING

Reduce Panel Thickness; Strengthen Locally with SikaReinforcer® Pads and Bulk Applications

**PANEL STIFFENING:** Weight reduction as a megatrend applies to all parts and materials in the automotive industry. Weight saving efforts can be applied on external panel sheet metal thicknesses, but there is often a negative effect. Visible deformations of surfaces can limit the benefits. With the application of stiffening pads or bulk applied stiffening materials, engineers and OEMs can meet performance targets while decreasing panel thicknesses through localized reinforcement only where it is required, with products engineered to eliminate panel distortion possibilities.

SikaReinforcer® stiffener pads and bulk formulations are designed to improve the stiffness required for panels in steel or aluminum protected with oils. To meet a wide range of specifications, various expansion ranges are available to support weight saving targets on the panels. Our diverse reinforcer selection also now includes a hybrid pad version which allows for reinforcement and damping in a single product.

The patches can be designed as a stiffening part produced with an extrusion process including a fiberglass textile top layer. The part will act as a hybrid sandwich with the panel to stiffen. Sika has proven expertise in the automated application of stiffener pads on assembly lines. Also available are pumpable bulk materials that can be robotically applied to targeted surfaces. All SikaReinforcer® bulk materials contain glass fibers, which serve to further reinforce the applied surface.

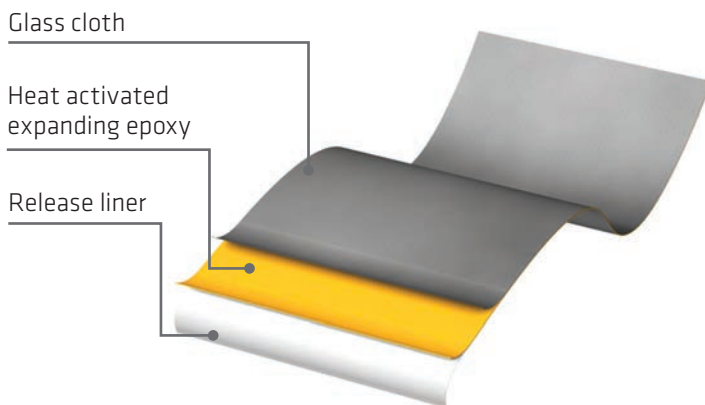

## BENEFITS

- Improves local stiffness
- Excellent adhesion on steel/aluminum
- Avoids read-through on external panels
- Long shelf life
- Potential of automatic application
- Can be tailored to any design

	SikaReinforcer®-540	SikaReinforcer®-200/201	SikaReinforcer®-660	SikaReinforcer®-670	SikaReinforcer®-671
<b>Performance</b>	damper /stiffener	stiffener			
<b>Type of material</b>	parts	bulk	parts		
<b>Polymer base</b>	reactive butyl	epoxy			
<b>Density</b>	1.5	1.5 – 1.6	1.4 – 1.5	1.3	1.3
<b>Expansion rate</b>	50 – 70 %	0 %	0 %	100 %	0 %
<b>Flexural strength</b>	2mm = 45 N Peak=135 N	2mm = 65 N Peak=125 N	2mm = 70 N Peak=245 N	2mm = 50 N Peak=200 N*	2mm = 70 N Peak=220 N*
<b>Application</b>	body shop				
<b>Bake conditions</b>	30 min @ 160°C and 15 min @ 180°C				

\*different glass clothes materials are available resulting in different values

# PROCESS ALTERNATIVES WITH STRUCTURAL TAPES

Bonding and Gap Filling with SikaReinforcer®

**VERSATILE SIKAREINFORCER® EXTRUDED STRUCTURAL TAPES** are suited for a variety of potential applications. Structural tapes can be produced in various lengths and widths, and the range of potential epoxy-based formulations with different expansion ranges allows service to a broad selection of designs. Structural tapes have serial tooling which allows for relatively short lead times, thus the materials can be used to solve last minute design challenges. Self adhesive tapes are placed manually into the cavity or seam of the body structure and are activated and cured during the standard e-coat oven process.

## BONDING OF TWO METAL SHEETS

Designed to allow bonding of two different sheet metals.

## GAP FILLING

Many body-in-white designs need connections between critical sheet metal nodes to reach high levels of performance in NVH or crash. Gap filling solutions in hidden areas, or areas without welding tool access, can be readily solved by using gap filling expanding structural foam. As an alternative to injection molded structural foam solutions, a simple self adhesive part can achieve these targets.

## BENEFITS

- Simple assembly process
- Simplified joining method
- Low/no tooling cost solution
- Flexible design possibilities

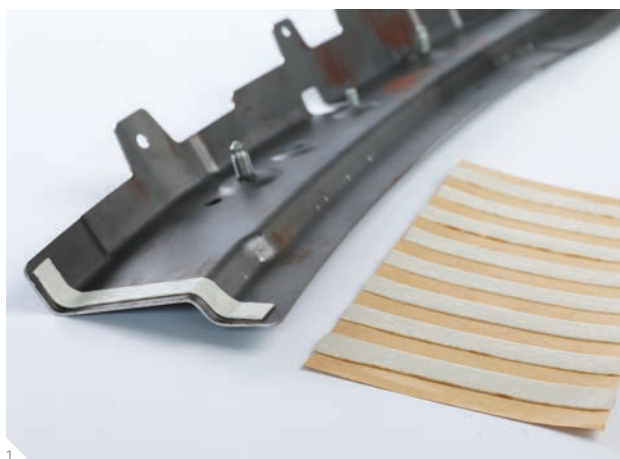

1 C-pillar junction with frame with extruded reinforcer tape



2 Replacement of structural adhesive with extruded structural tapes



# PRODUCT SPECIFICATION

During car body developments, designers often face stiffness or crash issues due to missing interconnections between sheet metal panels where standard joining processes are difficult to implement. Structural tapes solve the issue by behaving like a structural adhesive in hidden areas inaccessible to tool access. In standard configurations a release film is placed on the upper side of the products to allow for handling purposes. If necessary the film can be removed.

## SikaReinforcer®-600

Low expanding, epoxy based structural tape material (self adhesive) with high mechanical properties. The material is designed to cure between two sheet metals which are in contact with the tape before curing.

## SikaReinforcer®-602

High expanding structural tape material (self adhesive) with high mechanical properties. Gap filling, expanding structural tapes can join two different sheet metal with high gaps in hidden areas. With expansion levels between 150 - 400 %. Our high expanding structural tape portfolio can cover many applications.

	SikaReinforcer®-600	SikaReinforcer®-602
Shelf Life	6 months	6 months
Curing Window	150 – 200 °C	170 – 200 °C
Expansion Rate	40 % (no gap filling)	400 % (gap filling)
Young Modulus	1500 MPa	300 MPa
Tensile Strength	18 MPa	4 MPa
Weldable	yes	no

Handling film

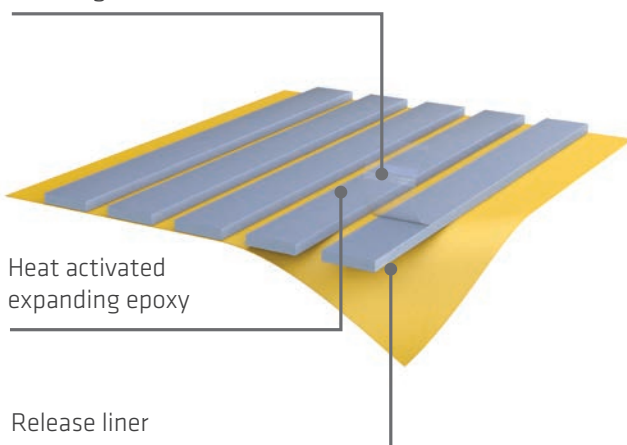

# INNOVATION, IT STARTS WITH PASSION

**AT SIKA, WE BELIEVE** that a truly innovative company is one that starts with a culture within which a passion for innovation and creativity thrive. An innovative company should also take a customer-focused view; one that anticipates customer needs with a thorough understanding of key market trends.



## **LIGHTER**

We have a full range of products which enable our customers to make their vehicles lighter. For example, we were the first to engineer body shop adhesives (SikaPower®), which enable mixed-material bonding of lighter materials such as aluminum, carbon fiber reinforced plastic, as well as traditional and high strength steels.



## **STRONGER AND SAFER**

We were the pioneer in vehicle exterior parts bonding with our Sikaflex® + Booster and SikaForce® products and our SikaReinforcer products, which not only help stiffen the vehicle for better overall dynamics but also improve crash performance and increase vehicle occupant safety.



## **QUIETER**

We provide solutions that make vehicles quieter; SikaBaffle® seals noise pathways, while SikaDamp® reduces the body panel vibration that contributes to audible noise in the vehicle. Both products are engineered for best-in-class weight-to-performance ratio. Used together, or separately, our industry leading acoustics solutions improve vehicle occupant comfort.



## **GREENER**

We were the first to establish water-based pre-treatments and polyurethane hotmelts with low monomeric isocyanate content and reactive polyolefin hotmelts free of classification to the automotive interior market – a more environmentally friendly approach that easily outperforms the industry's previous generation of products.



## **VALUE-ADDED INNOVATION**

We continuously develop new, cost-effective solutions, which allow our customers to use less material or reduce complexity in their manufacturing process. SikaPower® structural adhesives, for example, allow the reduction of welds in vehicle body sections, while strengthening overall crash durability. Anticipating megatrends we also offer a full range of solutions for assembly of e-mobility components and vehicles

# START WITH SIKA

MORE THAN

**50% OF ALL VEHICLES**

USE SIKA PRODUCTS AND TECHNOLOGIES

**30 MILLION VEHICLES**

PRODUCED ANNUALLY WORLDWIDE CONTAIN SIKA LAMINATION ADHESIVES

**25 MILLION PLUS**

VEHICLES MADE STRONGER AND SAFER EACH YEAR WITH OUR BODY SHOP ADHESIVES

**30% WEIGHT REDUCTION**

IN THE CAR BODY CAN BE ACHIEVED WHEN SIKA® PROPRIETARY HIGH-STRENGTH BONDING SOLUTIONS ARE USED IN CONJUNCTION WITH LIGHTWEIGHT MATERIALS AND THINNER MATERIAL CONSTRUCTION

MORE THAN

**300,000 LITERS**

OF VOCs WERE REDUCED THROUGH THE USE OF SIKA'S PRIMERLESS TO GLASS WATER-BASED PRE-TREATMENT SYSTEMS

MORE THAN

**70 MILLION**

CAR WINDOWS ARE BONDED DURING ASSEMBLY USING SIKAFLEX®

SIKA HAS

**20,000+ EMPLOYEES**

IN OVER

**100 COUNTRIES**

MORE THAN

**700 MILLION**

PARTS BASED ON OUR SIKABAFFLE®, SIKADAMP® AND SIKAREINFORCER® TECHNOLOGIES ARE SUPPLIED ANNUALLY TO THE GLOBAL AUTOMOTIVE INDUSTRY

MORE THAN

**30%**

INTERIOR NOISE REDUCTION IN VEHICLES THANKS TO SIKA'S ACOUSTIC SOLUTIONS

# GLOBAL REACH BUT LOCAL PARTNERSHIP

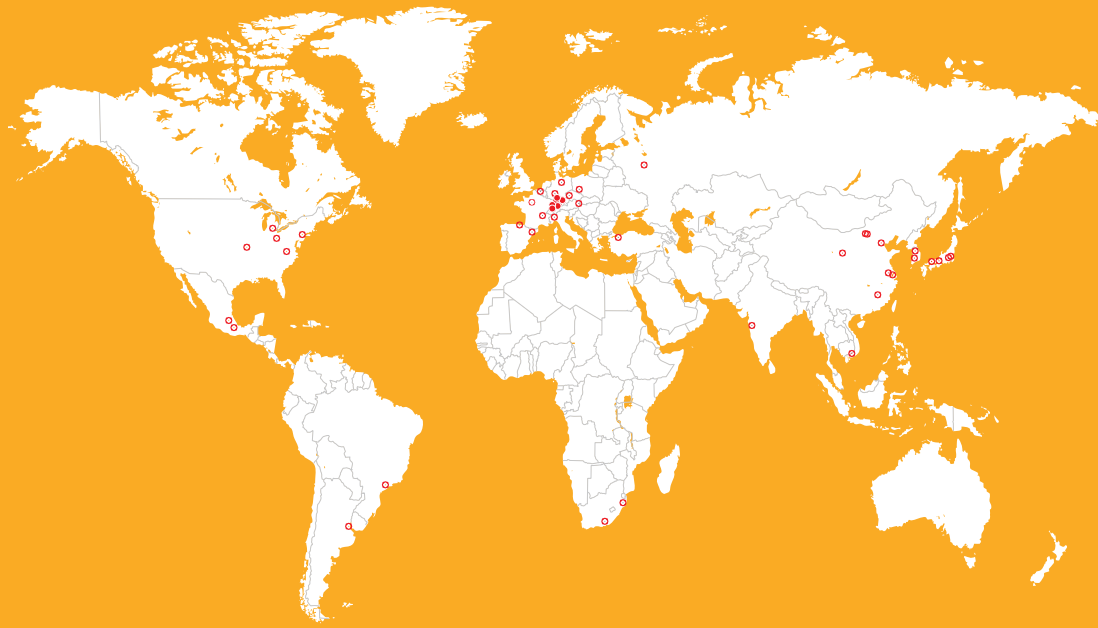

## START WITH SIKA THROUGH ANY OF THE CONTACT POINTS BELOW:

### EUROPE

Sika Automotive AG  
Kreuzlingerstrasse 35  
CH-8590 Romanshorn  
+41 58 436 58 01

Sika Automotive  
Hamburg GmbH  
Reichsbahnstrasse 99  
DE-22525 Hamburg  
+49 40 540 020

Sika Automotive  
Frankfurt-Worms GmbH  
Weinsheimer Str. 96  
DE- 67547 Worms  
+49 62 41 3 010

Sika Automotive Belgium S.A.  
Avenue Landas 2  
Zoning Industriel  
BE-1480 Tubize - Saintes  
+32 2 367 21 20

Sika Turkey Otomotiv San. ve  
Tic. Ltd. Şti.  
Yenişehir Mh. Reyhan Cd.,  
Enginsu Sit. VL1 D:37/12  
34912 Pendik/Istanbul  
Phone: +90 216 5600-801

### AMERICAS

Sika Automotive N.A.  
30800 Stephenson Hwy.  
US-Madison Heights, MI 48071  
+1 248 577 0020

Sika S.A.  
Av. Dr. Alberto Jackson  
Byington, 1525  
CEP 06276-000 Osasco  
BR-São Paulo  
+55 11 2877 6521

Sika Mexicana S.A. DE C.V.  
Carretera Libre a Celaya Km 8.5  
Fracc. Ind. Balvanera  
Corregidora, Qro.  
CP 76920  
MX-Querétaro  
+52 442 238 5800

### ASIA PACIFIC

Sika Ltd.  
Akasaka-K-Tower 7F, 1-2-7  
Moto-Akasaka, Minato-ku  
JP-107-0051 Tokyo  
+81 4 6321 1101

Sika Korea Ltd.  
35-8 nonhyeon-dong  
Gangnam-gu  
KR-135-815 Seoul  
+82 31 8056 7777

Sika India Pvt. Ltd.  
501 & 502, B Wing,  
Lotus Corporate Park, Goregoan East  
IN-Mumbai 400063  
+91 22 4038 4038

Sika (China) Ltd.  
No. 28 Jing Dong Road  
Suzhou Industrial Park  
CN-215121 Suzhou  
+86 512 6273 2888

Our most current General Sales Conditions shall apply.  
Please consult the most current local Product Data Sheet prior to any use.

